



OUTDOOR-ASSORTMENT LIST 2023



Your contact:

Hettich Marketing- und Vertriebs GmbH & Co. KG

Gerhard-Lüking-Str. 10

32602 Vlotho

Germany

P.O. Box 1743

32591 Vlotho

Germany

Phone: +49 5733 798 0

E-Mail: info@hettich.com

Internet: outdoor.hettich.com

Assortment for Outdoor-kitchens

- ▶ Summary of ranges
- ▶ Fittings

InnoTech Atira double walled drawer system 6 - 12
Stainless steel screws 7, 9 - 11
CargoPlus Wire shelf and Plate holer 13
Quadro Compact guide system for
InnoTech Atira, Stainless steel screws 14 - 15



Interior organisation system
for drawers and internal drawers 16 - 17



Waste collecting systems for InnoTech Atira
drawer system
Behind front panels, Pull 18 - 19
Behind front panels, Pot-and-pan drawer 20 - 21
Bio Box 22



Quadro Compact
Installing shelf for gas bottle pull-out,
Catches for pull-out shelf applications,
Stainless steel screws 23



Veosys Stainless steel hinge
Mounting plates and accessories
for hinged doors 24 - 25



ComfortSpin turntable 26



ProDecor stainless steel handles and knobs 27 - 30



Stainless steel screws 31 - 32



Assortment for Outdoor-kitchens

- ▶ Application summary
- ▶ Fittings



ProDecor stainless steel handle collection

K hinges and Quadro Compact runners for outdoor refrigerators

Waste systems for InnoTech Atira drawer system

  Find out more on our outdoor landing page: outdoor.hettich.com





ComfortSpin turntable

Veosys stainless steel hinge

Bottom panel mounted Quadro Compact runner for gas bottle pull-out

InnoTech Atira drawer system

Drawer and pot-and-pan drawer

Quadro Compact runner for InnoTech Atira

CargoPlus wire shelf and Plate holder for InnoTech Atira

Interior organisation for InnoTech Atira

Stainless steel screws

InnoTech Atira double walled drawer system

- ▶ Drawer, height 70 mm, Powder coated steel, silver / white / anthracite
- ▶ Stainless steel chipboard screws, countersunk



Drawer, set packaging

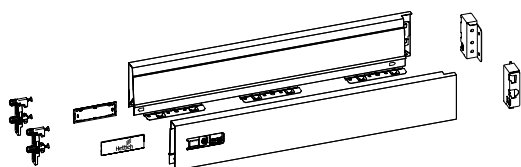

- Set comprises:
- ▶ 1 drawer side profile, left and right
 - ▶ 2 drawer front connectors with expanding dowel for drawer side profile
 - ▶ 2 plastic cover caps, plastic with Hettich logo
 - ▶ 1 rear panel connector, left and right
 - ▶ Aluminium rear panel see page 11
 - ▶ Fixing material (For outdoor use, we recommend stainless steel screws)
 - ▶ Suitable for outdoor use in line with DIN EN 1670, class 3

Nominal length mm	Order no. / colour			PU	Price
	silver	white	anthracite		
470	9 307 113	9 307 140	9 307 127	1 set	
520	9 307 115	9 307 142	9 307 129	1 set	

Drawer side profile, bulk packaging

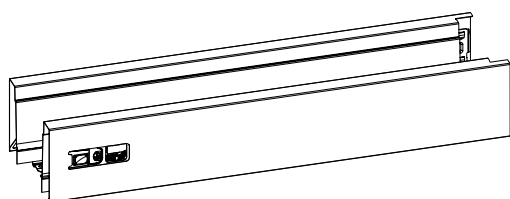

- ▶ Integrated vertical and lateral adjustment
- ▶ Powder coated steel

Nominal length mm	Order no. / colour / mounting side						PU	Price
	silver		white		anthracite			
	left	right	left	right	left	right		
470	9 194 398	9 194 399	9 194 412	9 194 413	9 194 426	9 194 427	18 ea.	
520	9 194 400	9 194 401	9 194 414	9 194 415	9 194 428	9 194 429	18 ea.	

Rear panel connector

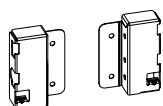

- ▶ Powder coated steel

Nominal height mm	Order no. / colour / mounting side						PU	Price
	silver		white		anthracite			
	left	right	left	right	left	right		
70	1 062 501	1 062 502	9 194 627	9 194 628	9 194 629	9 194 630	40 ea.	

InnoTech Atira double walled drawer system

- ▶ Drawer, height 70 mm, Powder coated steel, silver / white / anthracite
- ▶ Stainless steel chipboard screws, countersunk

Drawer front connector for drawer side profile

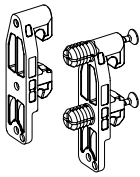

- ▶ Plastic, white

Mounting option	Order no.	PU	Price
With expanding socket	1 061 450	400 ea.	

Cover caps

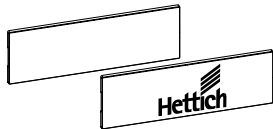

- ▶ Cover cap with customised imprint available on request
- ▶ Plastic

System colour	Finish	Order no.	PU	Price
silver	grey with Hettich logo	9 194 646	300 ea.	
white	white with Hettich logo	9 194 647	300 ea.	
anthracite	dark grey with Hettich logo	9 194 648	300 ea.	

Chipboard screws, panhead – for CargoPlus wire shelf for InnoTech Atira drawer system



- ▶ Screw for rear panel connector and CargoPlus wire shelf, drawer side profile height 70 / 144 mm
- ▶ Panhead ▶ Pozidrive screw ▶ Stainless steel

Dimensions mm	Order no.	PU	Price
ø 3,5 x 12	9 338 474	200 ea.	

- ▶ Screw for rear panel connector, drawer side profile height 70 mm
- ▶ Panhead ▶ Pozidrive screw ▶ Stainless steel

Dimensions mm	Order no.	PU	Price
ø 3,5 x 20	9 338 475	200 ea.	

Chipboard screws, countersunk head – for InnoTech Atira drawer system



- ▶ Screw for connecting front panel to screw on drawer side profile
- ▶ Countersunk head ▶ Pozidrive screw ▶ Stainless steel

Dimensions mm	Order no.	PU	Price
ø 3,5 x 25	9 338 476	200 ea.	

- ▶ Screw for attaching rear panel / base, from 600 cabinet body width
- ▶ Countersunk head ▶ Pozidrive screw ▶ Stainless steel

Dimensions mm	Order no.	PU	Price
ø 3,5 x 30	9 338 477	200 ea.	

InnoTech Aтира double walled drawer system

- ▶ Pot-and-pan drawer with railing, height 144 mm, Powder coated steel, silver / white / anthracite
- ▶ Stainless steel chipboard screws, countersunk



Pot-and-pan drawer, set packaging

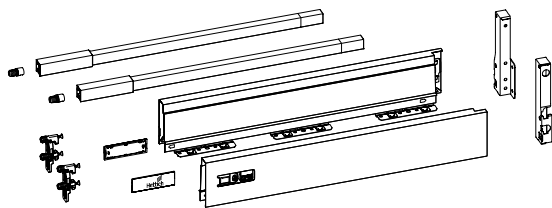

Set comprises:

- ▶ 1 drawer side profile, left and right
- ▶ 2 drawer front connectors with expanding dowel for drawer side profile
- ▶ 2 plastic cover caps, plastic with Hettich logo
- ▶ 1 lengthwise railing, left and right
- ▶ 2 drawer front connectors with expanding dowel for lengthwise railing
- ▶ 1 rear panel connector, left and right
- ▶ Aluminium rear panel see page 11
- ▶ Fixing material (For outdoor use, we recommend stainless steel screws)
- ▶ Suitable for outdoor use in line with DIN EN 1670, class 3

Nominal length mm	Order no. / colour			PU	Price
	silver	white	anthracite		
470	9 307 206	9 307 220	9 307 213	1 set	
520	9 307 207	9 307 221	9 307 214	1 set	

Drawer side profile, bulk packaging

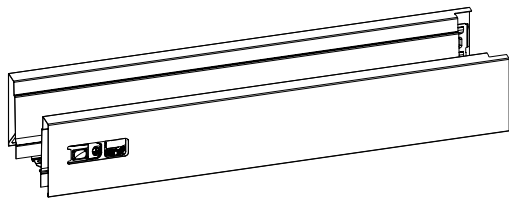

- ▶ Integrated vertical and lateral adjustment
- ▶ Powder coated steel

Nominal length mm	Order no. / colour / mounting side						PU	Price
	silver		white		anthracite			
	left	right	left	right	left	right		
470	9 194 398	9 194 399	9 194 412	9 194 413	9 194 426	9 194 427	18 ea.	
520	9 194 400	9 194 401	9 194 414	9 194 415	9 194 428	9 194 429	18 ea.	

Rear panel connector

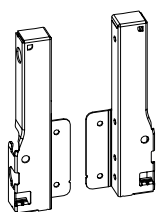

- ▶ Powder coated steel

Nominal height mm	Order no. / colour / mounting side						PU	Price
	silver		white		anthracite			
	left	right	left	right	left	right		
144	9 007 355	9 007 356	9 194 635	9 194 636	9 194 637	9 194 638	40 ea.	

InnoTech Atira double walled drawer system

- ▶ Pot-and-pan drawer with railing, height 144 mm, Powder coated steel, silver / white / anthracite
- ▶ Stainless steel chipboard screws, countersunk

Drawer front connector for drawer side profile

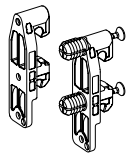

- ▶ Plastic, white

Drawer front connector for lengthwise railing



- ▶ Plastic, white

Mounting option	Order no.	PU	Price
With expanding socket	1 061 450	400 ea.	

Mounting option	Order no.	PU	Price
With expanding socket	1 061 965	400 ea.	

Cover caps

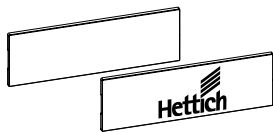

- ▶ Cover cap with customised imprint available on request
- ▶ Plastic

System colour	Finish	Order no.	PU	Price
silver	grey with Hettich logo	9 194 646	300 ea.	
white	white with Hettich logo	9 194 647	300 ea.	
anthracite	dark grey with Hettich logo	9 194 648	300 ea.	

Lengthwise railing

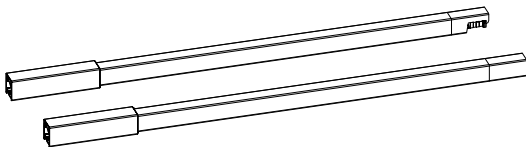

- ▶ Powder coated steel

Nominal length mm	Order no. / colour / mounting side						PU	Price
	silver		white		anthracite			
	left	right	left	right	left	right		
470	9 194 530	9 194 531	9 194 544	9 194 545	9 194 558	9 194 559	80 ea.	
520	9 194 532	9 194 533	9 194 546	9 194 547	9 194 560	9 194 561	80 ea.	

Chipboard screws, panhead - for CargoPlus wire shelf for InnoTech Atira drawer system



- ▶ Screw for rear panel connector and CargoPlus wire shelf, drawer side profile height 70 / 144 mm
- ▶ Panhead ▶ Pozidrive screw ▶ Stainless steel

Dimensions mm	Order no.	PU	Price
ø 3,5 x 12	9 338 474	200 ea.	

- ▶ Screw for rear panel connector, drawer side profile height 70 mm
- ▶ Panhead ▶ Pozidrive screw ▶ Stainless steel

Dimensions mm	Order no.	PU	Price
ø 3,5 x 20	9 338 475	200 ea.	

InnoTech Atira double walled drawer system

- ▶ Pot-and-pan drawer with railing, height 144 mm, Powder coated steel, silver / white / anthracite
- ▶ Stainless steel chipboard screws, countersunk

Chipboard screws, countersunk head – for InnoTech Atira drawer system



- ▶ Screw for connecting front panel to screw on drawer side profile
- ▶ Countersunk head ▶ Pozidrive screw ▶ Stainless steel

Dimensions mm	Order no.	PU	Price
ø 3,5 x 25	9 338 476	200 ea.	

- ▶ Screw for attaching rear panel / base, from 600 cabinet body width
- ▶ Countersunk head ▶ Pozidrive screw ▶ Stainless steel

Dimensions mm	Order no.	PU	Price
ø 3,5 x 30	9 338 477	200 ea.	

InnoTech Atira double walled drawer system

- ▶ Rear panel options drawer, height 70 mm, Pot-and-pan drawer with railing, height 144 mm
- ▶ Stainless steel chipboard screws, Panhead – Countersunk head

Aluminium rear panel

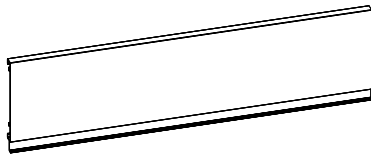

- ▶ For cutting to length
- ▶ Length 2000 mm
- ▶ Powder coated aluminium
- ▶ Base length (BL) = nominal length (NL) - 3

Colour	Order no. / nominal height		PU	Price
	70	144		
silver	0 077 913	0 013 225	1 ea.	
white	9 194 518	9 194 520	1 ea.	
anthracite	9 194 519	9 194 521	1 ea.	

Chipboard screws, panhead – for CargoPlus wire shelf and rear panel connector for InnoTech Atira drawer system



- ▶ Screw for rear panel connector and CargoPlus wire shelf, drawer side profile height 70 / 144 mm
- ▶ Panhead ▶ Pozidrive screw ▶ Stainless steel

Dimensions mm	Order no.	PU	Price
ø 3,5 x 12	9 338 474	200 ea.	

- ▶ Screw for rear panel connector, drawer side profile height 70 mm
- ▶ Panhead ▶ Pozidrive screw ▶ Stainless steel

Dimensions mm	Order no.	PU	Price
ø 3,5 x 20	9 338 475	200 ea.	

Chipboard screws, countersunk head – for InnoTech Atira drawer system



- ▶ Screw for attaching rear panel / base, from 600 cabinet body width
- ▶ Countersunk head ▶ Pozidrive screw ▶ Stainless steel

Dimensions mm	Order no.	PU	Price
ø 3,5 x 30	9 338 477	200 ea.	

InnoTech Aтира double walled drawer system

- ▶ Design options
- ▶ Connection for thin front panels in a thickness of 10 mm and over



- ▶ For front panel thicknesses from 10 mm
- ▶ Socket for optimum fit in soft materials (MDF transverse tensile strength > 0.6 N/mm², chipboard transverse tensile strength > 0.45 N/mm²)
- ▶ Self tapping screws for optimum fit in hard materials (e.g. solid surface material, natural stone, plastic, ceramic)
- ▶ For outdoor use, we recommend stainless steel screws
- ▶ Use with standard front panel connections
- ▶ The attachment method must be suitable for the type and quality of door material and tested for a secure fit

Connection for drawer side profile

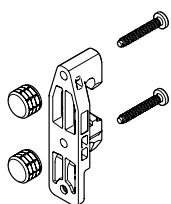

- Set comprises:
- ▶ 2 front connectors for drawer side profile
 - ▶ 4 sockets, \varnothing 10 x 8 mm
 - ▶ 4 self tapping screws, \varnothing 3.5 x 22 mm

Order no.	PU	Price
9 268 143	1 set	

Connection for lengthwise railing

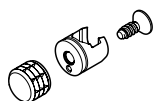

- Set comprises:
- ▶ 2 front connectors for lengthwise railing
 - ▶ 2 sockets, \varnothing 10 x 8 mm
 - ▶ 2 self tapping screws, \varnothing 3.5 x 9.5 mm

Order no.	PU	Price
9 268 145	1 set	

Fitting information

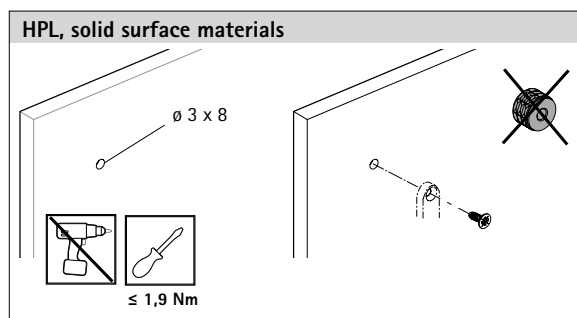
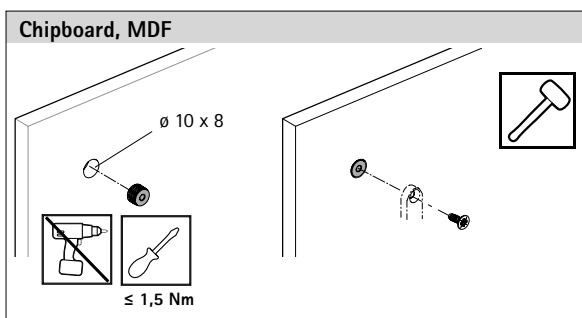

The attachment method must be suitable for the type and quality of door material and tested for a secure fit.

InnoTech Atira double walled drawer system

- ▶ CargoPlus wire shelf for drawer side profile height 70 / 144 mm
- ▶ Accessories, Plate holder for drawer side profile height 144 mm

Advice

- ▶ Stainless steel chromated SS 201
- ▶ Suitable for outdoor use in line with DIN EN 1670, class 3

For outdoor use, we recommend stainless steel screws.

CargoPlus wire shelf



Available for 3 different external cabinet body widths of 450 mm, 600 mm and 900 mm and two different cabinet body depths of 470 mm and 520 mm for 16 mm cabinet body thickness, drawer side profile height 70 / 144 mm.

Set comprises:

- ▶ 4 clip fasteners
- ▶ 2 plastic supports, grey plastic
- ▶ For outdoor use, we recommend using stainless steel screws, see order number **9 338 474**

Wire shelf width in mm	Outer cabinet body width in mm (for 16 mm side panel thickness)	Order no. / Nominal length		PU	Price
		470 mm	520 mm		
312	450	9 216 602	9 216 605	1 ea.	
462	600	9 216 603	9 216 606	1 ea.	
762	900	9 216 604	9 216 607	1 ea.	

CargoPlus plate holder 450 mm und 600 mm cabinet body width



- ▶ Can take up to 10 regular sized plates (250 mm diameter) for 450 mm cabinet body width & 16 regular sized plates (250 mm diameter) for 600 mm cabinet body width
- ▶ Dimensions:
450 mm Width and 470 mm Depth
 (312 wide x 459 deep x 135 mm high)
 Standing surface behind plate rack: 210 mm Depth
450 mm Width and 520 mm Depth
 (312 wide x 509 deep x 135 mm high)
 Standing surface behind plate rack: 260 mm Depth
600 mm Width and 470 mm Depth
 (462 wide x 459 deep x 135 mm high)
 Standing surface behind plate rack: 210 mm Depth
600 mm Width and 520 mm Depth
 (462 wide x 509 deep x 135 mm high)
 Standing surface behind plate rack: 260 mm Depth
- ▶ Recommended shutter height \geq 360 mm
- ▶ Please order InnoTech drawer side profile sets and runner separately

Outer cabinet body width in mm (for 16 mm side panel thickness)	Order no. / Nominal length		PU	Price
	470 mm	520 mm		
450	9 216 609	9 216 612	1 ea.	
600	9 216 615	9 216 618	1 ea.	

CargoPlus plate holder 900 mm cabinet body width



- ▶ Can take up to 16 regular sized plates (250 mm diameter)
- ▶ **900 mm Width and 470 mm Depth**
 (762 wide x 459 deep x 163 mm high)
 Standing surface behind plate rack: 210 mm Depth
900 mm Width and 520 mm Depth
 (762 wide x 509 deep x 163 mm high)
 Standing surface behind plate rack: 260 mm Depth
- ▶ Recommended shutter height \geq 360 mm
- ▶ Please order InnoTech drawer side profile sets and runner separately

Outer cabinet body width in mm (for 16 mm side panel thickness)	Order no. / Nominal length		PU	Price
	470 mm	520 mm		
900	9 216 620	9 216 621	1 ea.	

InnoTech Atira double walled drawer system

- ▶ **Quadro Compact runner system – Silent System**
- ▶ **Full extension runner, loading capacity 40 kg, Stainless steel screw**



- ▶ With integrated **Silent System**
- ▶ Slide on installation
- ▶ Installed width 12.5 mm (cabinet body side thickness 16 mm)
- ▶ Suitable for outdoor use in line with DIN EN 1670, class 3
- ▶ Load capacity to EN 15338, Level 3
- ▶ Custom finish
- ▶ For outdoor use, we recommend stainless steel screws

Set packaging

Nominal length / drawer length NL mm	Order no. / User friendly features Silent System	PU	Price
470	9 314 621	1 pair	
520	9 314 623	1 pair	

Bulk packaging

Nominal length / drawer length NL mm	Order no. / User friendly features / Mounting side Silent System		PU	Price
	left	right		
470	9 311 544	9 311 545	16 ea.	
520	9 314 053	9 314 054	16 ea.	

Direct fixing screws



- ▶ Countersunk head
- ▶ Pozidrive screw
- ▶ Nickel plated

Dimensions mm	Order no.	PU	Price
ø 6,3 x 14	0 051 265	200 ea.	

Chipboard screws, countersunk head



- ▶ Countersunk head
- ▶ Pozidrive screw
- ▶ Stainless Steel

Dimensions mm	Order no.	PU	Price
ø 4 x 16	9 338 501	200 ea.	

InnoTech Atira double walled drawer system

- ▶ **Quadro Compact runner system – Push to open**
- ▶ **Full extension runner, loading capacity 40 kg, Synchronisation**



- ▶ With integrated **Push to open**
- ▶ Slide on installation
- ▶ Installed width 12.5 mm (cabinet body side thickness 16 mm)
- ▶ Suitable for outdoor use in line with DIN EN 1670, class 3
- ▶ Load capacity to EN 15338, Level 3
- ▶ Custom finish
- ▶ For outdoor use, we recommend stainless steel screw (see page 14)

Set packaging

Nominal length / drawer length NL mm	Order no. / User friendly features Push to open	PU	Price
470	9 314 622	1 pair	
520	9 314 624	1 pair	

Bulk packaging

Nominal length / drawer length NL mm	Order no. / User friendly features / Mounting side Push to open		PU	Price
	left	right		
470	9 311 546	9 311 547	16 ea.	
520	9 314 055	9 314 056	16 ea.	

Synchronisation for Quadro Compact with Push to open

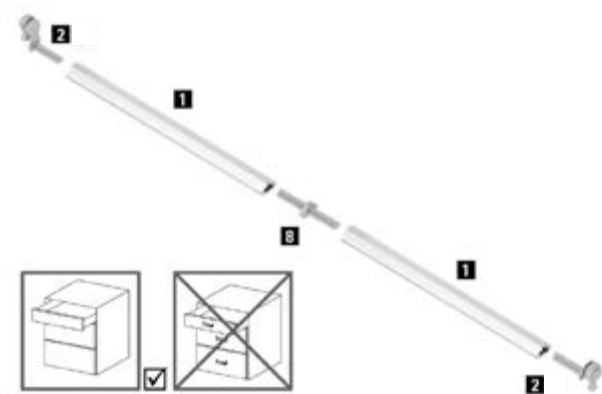

When using drawers larger than 600 mm, we recommend using a synchronisation bar:

- ▶ For cutting to length, length 1097 mm
- ▶ Aluminium anodised

Connector:

- ▶ For extending synchronisation bar / optimising synchronisation bar
offcut waste
- ▶ Plastic, grey

Article	Order no.	PU	Price
1 Synchronisation bar	9 219 967	100 ea.	
2 Adapters, type A	9 219 966	200 ea.	
8 Connectors	9 221 295	20 ea.	

Interior organisation system for drawers and internal drawers

- ▶ For InnoTech Atira drawer system
- ▶ OrgaTray 590



- ▶ Plastic cutlery and utensil tray
- ▶ Adapted to standard cabinet body width 300 - 1000 mm
- ▶ For 470 mm drawer side profile depth
- ▶ For 70 mm drawer side profile height
- ▶ Climate-resistant, dimensionally stable and fracture proof for 24h at 70°C and at -30°C, free fall from 1m

OrgaTray 590

Cabinet body width mm	Order no. / colour / nominal length mm								
	silver			white			anthracite		
	470	PU	Price	470	PU	Price	470	PU	Price
300	9 194 886	1 ea.		9 194 897	1 ea.		9 194 908	1 ea.	
400	9 194 887	1 ea.		9 194 898	1 ea.		9 194 909	1 ea.	
450	9 194 888	1 ea.		9 194 899	1 ea.		9 194 910	1 ea.	
500	9 194 889	1 ea.		9 194 900	1 ea.		9 194 911	1 ea.	
550	9 194 890	1 ea.		9 194 901	1 ea.		9 194 912	1 ea.	
600	9 194 891	1 ea.		9 194 902	1 ea.		9 194 913	1 ea.	
800	9 194 892	1 ea.		9 194 903	1 ea.		9 194 914	1 ea.	
900	9 194 893	1 ea.		9 194 904	1 ea.		9 194 915	1 ea.	
1000	9 194 894	1 ea.		9 194 905	1 ea.		9 194 916	1 ea.	

Divider

NL	T	Diagram									
420	412	[Grid diagrams showing various divider configurations for different cabinet widths and depths]									
B	KB	207	307	357	407	457	507	707	807	907	
		300	400	450	500	550	600	800	900	1000	
NL = Nominal length T = Depth B = Width KB = Cabinet body width											

Interior organisation system for drawers and internal drawers

- ▶ For InnoTech Atira drawer system
- ▶ OrgaTray 490



- ▶ Plastic cutlery and utensil tray
- ▶ Can be fitted in cabinet bodies in widths of 450 mm and over
- ▶ 2 can be fitted in cabinet bodies in widths of 800 mm and over
- ▶ For 470 mm and 520 mm drawer side profile depth
- ▶ For 70 mm drawer side profile height
- ▶ Climate-resistant, dimensionally stable and fracture proof for 24h at 70°C and at -30°C, free fall from 1m

OrgaTray 490

Nominal length mm	Order no. / colour			PU	Price
	silver	white	anthracite		
470	9 207 241	9 207 243	9 207 246	1 ea.	
520	9 207 242	9 207 245	9 207 247	1 ea.	

Divider

NL 470	T 462		NL 520	T 512	
B	324		B	324	
KB	≥ 450		KB	≥ 450	
NL = Nominal length T = Depth B = Width KB = Cabinet body width					

Advice

- ▶ Further interior organisation elements and accessories available on request

Waste collecting systems for InnoTech Atira drawer system

- ▶ Waste collecting systems behind front panels
- ▶ InnoTech Pull



- ▶ Top running waste bins for InnoTech Atira drawer, 70 mm high
- ▶ The InnoTech Pull frame is fitted instead of the drawer bottom panel
- ▶ Frame can be equipped as required with various bins and accessories
- ▶ InnoTech Atira drawer components must be ordered separately
- ▶ Climate-resistant, dimensionally stable and fracture proof for 24h at 70°C and at -30°C, free fall from 1m
- ▶ Powder coated steel, anthracite

Set comprises:

- ▶ 1 fitted frame including front stay and lid
- ▶ Fixing material
- ▶ For outdoor use, we recommend using stainless steel screws, see order numbers **9 338 472** and **9 338 473**

InnoTech Pull frame

For cabinet body width mm	Type	Order no. / Nominal length mm	PU	Price
		470		
300		9 279 409	1 set	
400		9 279 410	1 set	
450		9 279 411	1 set	
500		9 279 412	1 set	
600		9 279 413	1 set	
600	600 - 2 (for 2 x 40 l)	9 279 414	1 set	

Partitioning

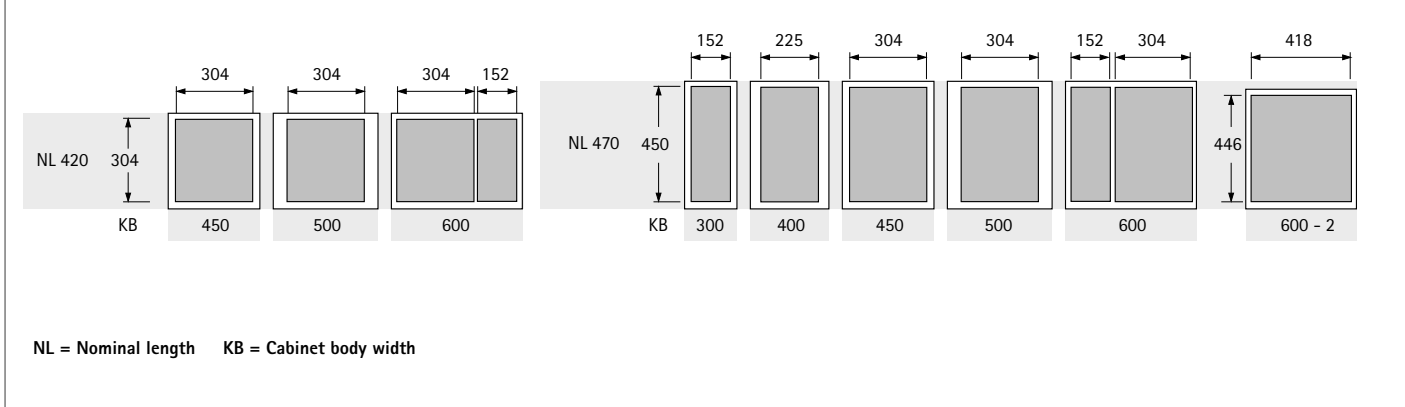

Planning dimensions

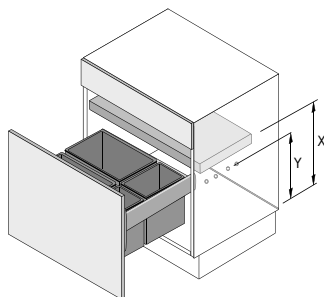

Bin height mm	X mm	Y mm
295	395	295
460	560	460
505	605	505

Waste collecting systems for InnoTech Atira drawer system

► Accessories

► Bins and lids for InnoTech Pull frame, stainless steel screws

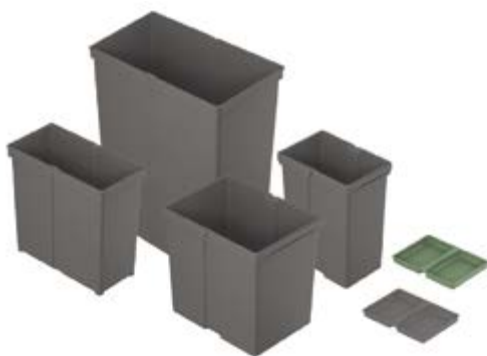

- For fitting any chosen component in the InnoTech Pull frame
- Plastic bins with sturdy double handle
- As standard, all bins are supplied without lid
- Lids must be ordered separately, see below
- The lid heights specified below are total dimensions, the additional height for all lids is 2 mm
- Climate-resistant, dimensionally stable and fracture proof for 24h at 70°C and at -30°C, free fall from 1m

Bins

Article	Material / finish	Width mm	Depth	Height mm	Order no.	PU	Price
Bin	Plastic anthracite	152	152	295	9 279 389	1 ea.	
Bin	Plastic anthracite	152	225	295	9 279 390	1 ea.	
Bin	Plastic anthracite	152	304	295	9 279 391	1 ea.	
Bin	Plastic anthracite	225	304	295	9 279 392	1 ea.	
Bin	Plastic anthracite	225	304	460	9 279 393	1 ea.	
Bin	Plastic anthracite	223	418	505	9 279 394	1 ea.	

Lids

Article	Material / finish	Width mm	Depth	Height mm	Order no.	PU	Price
Bin	Plastic anthracite	152	152	21	9 279 395	1 ea.	
Bin	Plastic anthracite	152	225	21	9 279 396	1 ea.	
Bin	Plastic green	152	225	21	9 132 382	1 ea.	
Lid	Plastic anthracite	152	304	21	9 279 397	1 ea.	
/ Lid	Plastic anthracite	225	304	21	9 279 398	1 ea.	
Lid	Plastic anthracite	223	418	21	9 279 399	1 ea.	

Chipboard screws, panhead



- Pozidrive screw
- Stainless steel

Article version	Dimensions mm	Order no.	PU	Price
Panhead screw	ø 4 x 12	9 338 472	200 ea.	
Panhead screw	ø 4 x 16	9 338 473	200 ea.	

Waste collecting systems for InnoTech Atira drawer system

- ▶ Waste collecting systems behind front panels
- ▶ Bin.it Prime

Bin.it Prime 600

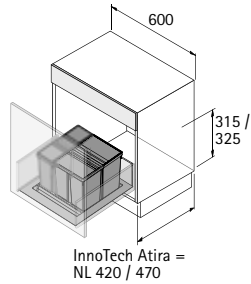

- ▶ For use in pot-and-pan drawer, for InnoTech Atira, nominal length (NL) 470 mm
- ▶ For cabinet width 600 mm
- ▶ Capacity 37 litres
- ▶ Installation height from top edge of cabinet body bottom panel for Innotech Atira, 315 mm
- ▶ Installed height 297 mm as from upper edge of drawer bottom panel
- ▶ Fitted tray height 45 mm
- ▶ Fitted tray can be cut to size, dimensions for cutting to size: max. width 540 mm, max. depth 490 mm min. width 430 mm, min. depth 399 mm
- ▶ Fitted tray, bins and lid, anthracite plastic
- ▶ Climate-resistant, dimensionally stable and fracture proof for 24h at 70°C and at -30°C, free fall from 1m

Set comprises:

- ▶ 2 bins with lid +
- ▶ 1 fitted tray

Order no.	PU	Price
9 220 394	1 set	

Bin.it Prime 900

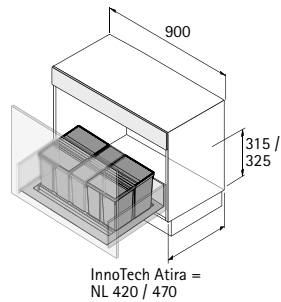

- ▶ For use in pot-and-pan drawer, for InnoTech Atira, nominal length (NL) 470 mm
- ▶ For cabinet width 900 mm
- ▶ Capacity 63 litres
- ▶ Installation height from top edge of cabinet body bottom panel for Innotech Atira, 315 mm
- ▶ Installed height 297 mm as from upper edge of drawer bottom panel
- ▶ Fitted tray height 45 mm
- ▶ Fitted tray can be cut to size, dimensions for cutting to size: max. width 540 mm, max. depth 490 mm min. width 430 mm, min. depth 399 mm
- ▶ Fitted tray, bins and lid, anthracite plastic
- ▶ Climate-resistant, dimensionally stable and fracture proof for 24h at 70°C and at -30°C, free fall from 1m

Set comprises:

- ▶ 3 bins with lid + +
- ▶ 1 fitted tray

Order no.	PU	Price
9 220 395	1 set	

Waste collecting systems for InnoTech Atira drawer system

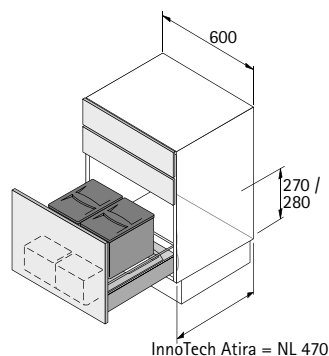

- ▶ Waste collecting systems behind front panels
- ▶ Bin.it Flex

Bin.it Flex 600



- ▶ For use in pot-and-pan drawer, for InnoTech Atira, nominal length (NL) 470 mm
- ▶ For cabinet width 600 mm
- ▶ Capacity 24 litres
- ▶ Installation height from top edge of cabinet body bottom panel for Innotech Atira, 270 mm
- ▶ Installed height 230 mm as from upper edge of drawer bottom panel
- ▶ Fitted tray height 45 mm
- ▶ Fitted tray can be cut to size, dimensions for cutting to size: max. width 540 mm, max. depth 490 mm min. width 503 mm, min. depth 422 mm
- ▶ Fitted tray, bins and lid, grey plastic
- ▶ Trays, translucent plastic
- ▶ Climate-resistant, dimensionally stable and fracture proof for 24h at 70°C and at -30°C, free fall from 1m

Set comprises:

- ▶ 2 bins with lid  + 
- ▶ 2 trays
- ▶ 1 fitted tray



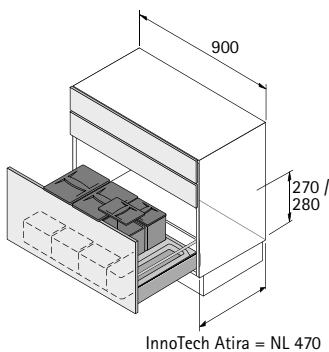

Order no.	PU	Price
9 132 349	1 set	

Bin.it Flex 900



- ▶ For use in pot-and-pan drawer, for InnoTech Atira, nominal length (NL) 470 mm
- ▶ For cabinet width 900 mm
- ▶ Capacity 35 litres
- ▶ Installation height from top edge of cabinet body bottom panel for Innotech Atira, 270 mm
- ▶ Installed height 230 mm as from upper edge of drawer bottom panel
- ▶ Fitted tray height 45 mm
- ▶ Fitted tray can be cut to size, dimensions for cutting to size: max. width 540 mm, max. depth 490 mm min. width 803 mm, min. depth 422 mm
- ▶ Fitted tray, bins and lid, grey plastic
- ▶ Trays, translucent plastic
- ▶ Climate-resistant, dimensionally stable and fracture proof for 24h at 70°C and at -30°C, free fall from 1m

Set comprises:

- ▶ 4 bins with lid  +  + 5  + 5 
- ▶ 3 trays
- ▶ 1 fitted tray

Order no.	PU	Price
9 132 350	1 set	

Waste collecting systems

- ▶ Built-in waste bins
- ▶ Bio Box

Bio Box



- ▶ Practical biodegradable waste collecting bin
- ▶ Can be hung on the front panel (max. front panel thickness 20 mm) or bar handle or placed directly on the worktop
- ▶ Dishwasher safe
- ▶ Capacity 5 litres
- ▶ Width 250 mm
Depth 188 mm
Height 184 mm
- ▶ Bin in white plastic, lid in grey translucent plastic
- ▶ Climate-resistant, dimensionally stable and fracture proof for 24h at 70°C and at -30°C, free fall from 1m

Order no.	PU	Price
9 207 654	1 ea.	



Gas bottle pull-out

- ▶ Quadro Compact runner system – bottom panel installation
- ▶ Full extension runner, loading capacity 40 kg

Quadro Compact with Silent System, 40 kg



- ▶ With integrated **Silent System**
- ▶ Slide on installation
- ▶ Suitable for outdoor use in line with DIN EN 1670, class 3
- ▶ Load capacity to EN 15338, Level 3
- ▶ Custom finish
- ▶ For outdoor use, we recommend stainless steel screws

Nominal length / Drawer length NL mm	Order no.	PU	Price
470	9 338 462	1 pair	

Catch for pull-out shelf application

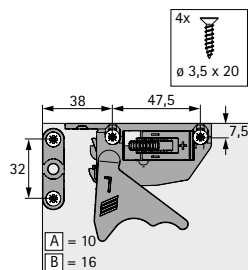

- ▶ Infinite height adjustment up to + 2 mm
- ▶ Plastic, black

Cabinet side	Order no.	PU	Price
left	9 117 483	100 ea.	
right	9 117 485	100 ea.	
left / right	9 117 492	5 pair	

Plugs



- ▶ For drawers with flush bottom panel and pull-out shelves
- ▶ Using the rear plug reduces the drawer length (NL) by 10 mm
- ▶ Plastic

Mounting position	Colour	Order no.	PU	Price
front	beige	0 047 216	200 ea.	
rear	white	0 073 213	200 ea.	

Direct fixing screws



- ▶ Countersunk head
- ▶ Pozidrive screw
- ▶ Nickel plated

Dimensions mm	Order no.	PU	Price
ø 6,3 x 14	0 051 265	200 ea.	

Chipboard screws, countersunk head



- ▶ Countersunk head
- ▶ Pozidrive screw
- ▶ Stainless Steel

Dimensions mm	Order no.	PU	Price
ø 4 x 16	9 338 501	200 ea.	

Stainless steel hinge, mounting

- ▶ Veosys
- ▶ Accessories, Screws

Veosys 105° - stainless steel hinge, 105° opening angle, drilling pattern TH 52 x 5,5 mm



- ▶ Concealed hinge with clip on installation and integrated Silent System
- ▶ For $\varnothing 4 \times 16$ mm countersunk screws*
- ▶ Quality classification under EN 15570, Level 2
- ▶ Corrosion proof, 120h NSS to DIN EN ISO 9227
- ▶ For door thickness of 14 - 22 mm
- ▶ Cup diameter 35 mm
- ▶ Cup depth 11.5 mm
- ▶ Stainless steel
- ▶ For outdoor use, we recommend stainless steel screws

Drilling pattern

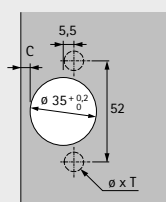

full overlay (Base B 11.5 mm)

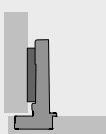

half overlay (Base B 3 mm)

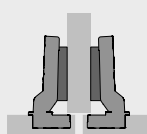

inset (Base B -6.5 mm)

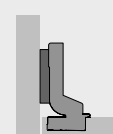

With integrated Silent System, with self closing feature

Cup assembly	Mounting hole $\varnothing \times T$ mm	full overlay			half overlay			inset		
		Order no.	PU	Price	Order no.	PU	Price	Order no.	PU	Price
for screwing on	-	9 289 590	200 ea.		9 289 592	200 ea.		9 289 595	200 ea.	

Cross mounting plate for screwing on

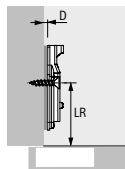

- ▶ For 4 mm $\varnothing \times 16$ mm countersunk screws*
- ▶ Quality classification under EN 15570, Level 2
- ▶ Corrosion proof, 120h NSS to DIN EN ISO 9227
- ▶ Hole spacing 32 mm
- ▶ Oblong hole height adjustment ± 3 mm
- ▶ Stainless steel

Hole line distance LR mm	Order no. / Distance D mm		PU	Price
	0.0	2.0		
37	9 289 598	9 289 609	200 ea.	

Chipboard screws, countersunk head



- ▶ Countersunk head
- ▶ Pozidrive screw
- ▶ Stainless Steel

Dimensions mm	Order no.	PU	Price
$\varnothing 4 \times 16$ (Hinge and mounting plate)*	9 338 501	200 ea.	

* The screw length is a recommendation and may vary depending on the furniture solution. The tight fit of the screw must be ensured by the installer.

Stainless steel hinge

- ▶ Veosys
- ▶ Accessories, Cover cap, Adapter

Cover cap for Veosys hinge arm



- ▶ Suitable for use with Veosys
- ▶ Stainless steel

Version	Order no.	PU	Price
embossed with Hettich logo	9 289 610	200 ea.	
neutral	9 289 611	200 ea.	

Adapter for reducing drilling depth

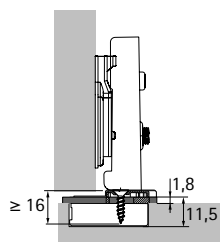

- ▶ To reduce the required depth of the cup drilling in thin or highly softened doors
- ▶ Can be used with hinge cup for screwing on
- ▶ The gap between cabinet body and door increases by the thickness of the adapter
- ▶ Attachment by $\varnothing 4 \times 16$ mm countersunk screws*
- ▶ Transparent plastic

Design	Thickness mm	Order no.	PU	Price
for drilling pattern TH	1.8	9 306 263	50 ea.	

Parallel adapter for cross mounting plates

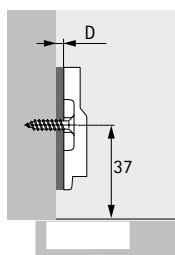

- ▶ For increasing mounting plate distance
- ▶ Stackable
- ▶ A trial mounting is recommended
- ▶ Plastic, grey

Distance D mm	Order no.	PU	Price
3.0	9 289 695	50 ea.	

Can only be used with Veosys cross mounting plates for screwing on, screw length is defined by the specific configuration

* The screw length is a recommendation and may vary depending on the furniture solution. The tight fit of the screw must be ensured by the installer.

ComfortSpin turntable

ComfortSpin



- ▶ Turntable for filling and optimising use of storage space
- ▶ For use in refrigerators or furniture (also for outdoors)
- ▶ Plastic
- ▶ Including Fixing material
(For outdoor use, we recommend stainless steel screws)

Colour	Order no.	PU	Price
anthracite	9 325 329	1 ea.	
transparent	9 325 328	1 ea.	

Chipboard screws, Panhead



- ▶ Panhead
- ▶ Pozidrive screw
- ▶ Stainless Steel

Dimensions mm	Order no.	PU	Price
ø 4 x 16	9 338 473	200 St.	

ProDecor stainless steel handles and knobs

Advice

- Suitable for outdoor use in line with DIN EN 1670, class 3 (for all ProDecor handles and knobs shown).
For outdoor use, we recommend stainless steel screws.

Guarani

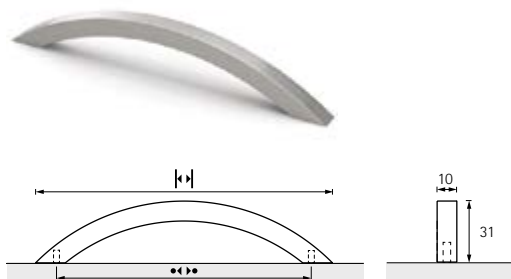

Version	Order no.	PU	Price
Brushed stainless steel BA128 / L149	9 208 046	50 ea.	
Brushed stainless steel BA160 / L181	9 208 047	50 ea.	
Brushed stainless steel BA192 / L223	9 208 048	50 ea.	
Brushed stainless steel BA224 / L259	9 208 049	50 ea.	

Narona

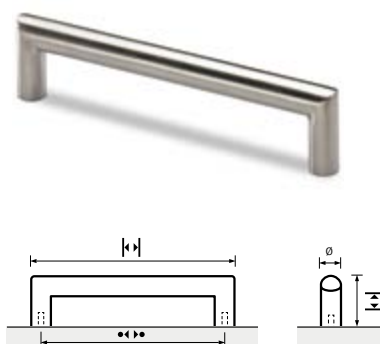

Version	Order no.	PU	Price
Brushed stainless steel BA96 / \varnothing 12	9 070 970	50 ea.	
Brushed stainless steel BA128 / \varnothing 12	9 070 973	25 ea.	
Brushed stainless steel BA160 / \varnothing 12	9 070 975	40 ea.	
Brushed stainless steel BA192 / \varnothing 12	9 070 992	40 ea.	
Brushed stainless steel BA224 / \varnothing 12	9 203 963	40 ea.	
Brushed stainless steel BA288 / \varnothing 12	9 070 995	50 ea.	
Brushed stainless steel BA320 / \varnothing 12	9 070 998	50 ea.	
Brushed stainless steel BA352 / \varnothing 12	9 070 977	25 ea.	
Brushed stainless steel BA384 / \varnothing 12	9 070 979	25 ea.	
Brushed stainless steel BA480 / \varnothing 12	9 071 000	25 ea.	
Brushed stainless steel BA640 / \varnothing 12	9 071 010	15 ea.	
Brushed stainless steel BA763 / \varnothing 12	9 071 013	15 ea.	

Vada

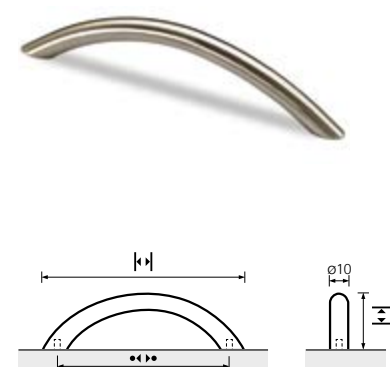

Version	Order no.	PU	Price
Brushed stainless steel BA64 / \varnothing 10	9 070 440	75 ea.	
Brushed stainless steel BA96 / \varnothing 10	9 070 446	50 ea.	
Brushed stainless steel BA128 / \varnothing 10	9 070 501	50 ea.	
Brushed stainless steel BA160 / \varnothing 10	9 070 451	50 ea.	
Brushed stainless steel BA192 / \varnothing 10	9 070 457	50 ea.	
Brushed stainless steel BA224 / \varnothing 10	9 070 504	50 ea.	
Brushed stainless steel BA256 / \varnothing 10	9 070 466	50 ea.	
Brushed stainless steel BA288 / \varnothing 10	9 070 509	50 ea.	
Brushed stainless steel BA320 / \varnothing 10	9 070 481	50 ea.	
Brushed stainless steel BA352 / \varnothing 10	9 070 494	50 ea.	

ProDecor stainless steel handles and knobs

Asopus

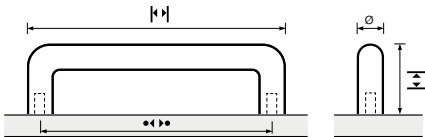

Version	Order no.	PU	Price
Brushed stainless BA64 / ø8	9 070 096	50 ea.	
Brushed stainless BA96 / ø8	9 069 942	50 ea.	
Brushed stainless BA128 / ø8	9 070 101	50 ea.	
Brushed stainless BA96 / ø10	9 069 815	50 ea.	
Brushed stainless BA128 / ø10	9 069 818	50 ea.	
Brushed stainless BA160 / ø10	9 070 124	75 ea.	
Brushed stainless BA192 / ø10	9 070 420	50 ea.	
Brushed stainless BA224 / ø10	9 069 821	50 ea.	
Brushed stainless BA320 / ø10	9 069 865	50 ea.	
Brushed stainless BA352 / ø10	9 070 421	25 ea.	
Brushed stainless BA96 / ø12	9 070 102	50 ea.	
Brushed stainless BA128 / ø12	9 070 103	50 ea.	
Brushed stainless BA160 / ø12	9 070 117	50 ea.	
Brushed stainless BA192 / ø12	9 070 105	50 ea.	
Brushed stainless BA224 / ø12	9 070 118	50 ea.	
Brushed stainless BA320 / ø12	9 070 119	50 ea.	
Brushed stainless BA352 / ø12	9 070 111	25 ea.	
Brushed stainless BA480 / ø12	9 070 120	25 ea.	
Brushed stainless BA704 / ø12	9 070 122	25 ea.	

Narni

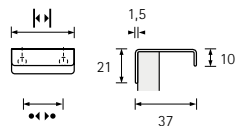

Version	Order no.	PU	Price
Brushed stainless BA20 / L30	9 995 574	75 ea.	
Brushed stainless BA50 / L60	9 158 400	50 ea.	
Brushed stainless BA80 / L90	9 206 741	50 ea.	

Aboa

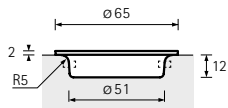

Version	Order no.	PU	Price
Brushed stainless ø65	9 070 138	25 ea.	

Onex

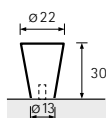

Version	Order no.	PU	Price
Brushed stainless ø22	9 113 565	100 ea.	

Agrinum



Version	Order no.	PU	Price
Brushed stainless ø14	9 070 263	200 ea.	
Brushed stainless ø18	9 070 264	125 ea.	

Monacum



Version	Order no.	PU	Price
Brushed stainless steel $\varnothing 10$	9 070 957	200 ea.	
Brushed stainless steel $\varnothing 14$	9 070 958	150 ea.	

Danum



Version	Order no.	PU	Price
Brushed stainless steel $\varnothing 20$	9 070 744	150 ea.	
Brushed stainless steel $\varnothing 25$	9 070 740	125 ea.	
Brushed stainless steel $\varnothing 30$	9 070 735	75 ea.	

Sion

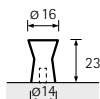

Version	Order no.	PU	Price
Brushed stainless steel $\varnothing 16$	9 113 564	100 ea.	

Spalatum

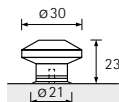

Version	Order no.	PU	Price
Brushed stainless steel $\varnothing 30$	9 070 580	100 ea.	

Sipontum

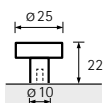

Version	Order no.	PU	Price
Brushed stainless steel $\varnothing 25$	9 070 568	75 ea.	

Serbinum

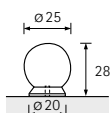

Version	Order no.	PU	Price
Brushed stainless steel $\varnothing 25$	9 070 562	75 ea.	

Arnum

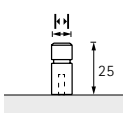

Version	Order no.	PU	Price
Brushed stainless steel 10 x 10 mm	9 208 071	150 ea.	
Brushed stainless steel 12 x 12 mm	9 208 072	150 ea.	

Handle fixing screws



- ▶ M4 thread
- ▶ Cross recessed head and double slot
- ▶ Galvanised steel

Length mm	Order no.	PU	Price
20	0 071 548	50 ea.	
22	0 071 549	50 ea.	
24	0 071 555	50 ea.	
26	0 071 556	50 ea.	
30	0 071 558	50 ea.	
32	0 071 559	50 ea.	

Chipboard screws, panhead – for CargoPlus wire shelf for InnoTech Atira drawer system



- ▶ Screw for rear panel connector and CargoPlus wire shelf, drawer side profile height 70 mm
- ▶ Panhead
- ▶ Pozidrive screw
- ▶ Stainless steel

Dimensions mm	Order no.	PU	Price
ø 3,5 x 12	9 338 474	200 ea.	

- ▶ Screw for rear panel connector, drawer side profile height 70 mm
- ▶ Panhead
- ▶ Pozidrive screw
- ▶ Stainless steel

Dimensions mm	Order no.	PU	Price
ø 3,5 x 20	9 338 475	200 ea.	

Chipboard screws, countersunk head – for InnoTech Atira drawer system



- ▶ Screw for connecting front panel to screw on drawer side profile
- ▶ Countersunk head
- ▶ Pozidrive screw
- ▶ Stainless steel

Dimensions mm	Order no.	PU	Price
ø 3,5 x 25	9 338 476	200 ea.	

- ▶ Screw for attaching rear panel / base, from 600 cabinet body width
- ▶ Countersunk head
- ▶ Pozidrive screw
- ▶ Stainless steel

Dimensions mm	Order no.	PU	Price
ø 3,5 x 30	9 338 477	200 ea.	

Chipboard screws, countersunk head – for Quadro Compact runner system, Veosys hinges and mounting plates



- ▶ Countersunk head
- ▶ Pozidrive screw
- ▶ Stainless Steel

Dimensions mm	Order no.	PU	Price
ø 4 x 16	9 338 501	200 ea.	

Chipboard screws, panhead - for waste collecting systems for InnoTech Atira Pull, ComfortSpin turntable



- ▶ Panhead
- ▶ Pozidrive screw
- ▶ Stainless Steel

Dimensions mm	Order no.	PU	Price
ø 4 x 12	9 338 472	200 ea.	
ø 4 x 16	9 338 473	200 ea.	

Order no.: 9 339 561
2305-007_OUTDOOR_ASSORTMENT_LIST_05/23_HMV_en



IT'S ALL
IN HETTICH